



# TL-2000 *Sting S4*

## PILOT'S OPERATING HANDBOOK

This Pilot's Operating Handbook must remain in the aircraft and be accessible to the pilot all times.

(THIS PAGE BLANK)

Dear Sting Owner:

Congratulations on the purchase of your Sting S4! You will find your new TL-ULTRALIGHT aircraft very enjoyable, extremely economical, and easy to maintain. The Sting S4 is the ideal ultralight airplane. It is fast, economical, pleasing to the eye, and user friendly. We at TL-ULTRALIGHT are certain that your Sting will give you hours and hours of leisure flying and enjoyment. With this Pilot Operating Handbook (POH), we hope to help inform you about the design and operation of your aircraft.

This Pilot Operating Handbook is to be used as a guide to assist the pilot to safely use the Sting S4 aircraft. The contents are not intended to be a final authority and although proofed extensively they are still not considered error free. Therefore, the pilot in command is the final authority for the safe operation of the aircraft. Should there be any questions or errors found in your reading this handbook please contact us immediately and we will issue a clarification. Please study and become familiar with this POH manual and the respective manuals for the propeller and rescue system.

Thank you again for your business. We look forward to a continuing satisfied customer relationship. Feel free to contact us if you have any questions or comments regarding your Sting aircraft.

Fly safe! Fly fun!

(sig)

*Jiří Tlustý*







- 1. GENERAL INFORMATION**
- 2. LIMITATIONS**
- 3. EMERGENCY PROCEDURES**
- 4. NORMAL PROCEDURES**
- 5. PERFORMANCE**
- 6. WEIGHT, BALANCE AND EQUIPMENT LIST**
- 7. DESCRIPTION OF AIRPLANE AND SYSTEMS**
- 8. HANDLING AND SERVICING**
- 9. SUPPLEMENTS**

	<b>Pilot's Operating Handbook</b>	Aircraft Type: TL - 2000 Sting S4
		Section 1 - General Information

Notice! The information contained in this document is for reference and information only.  
The pilot is the final and only responsible party for the safe operation of this aircraft.

# 1. GENERAL INFORMATION

## TABLE OF CONTENTS

1.1 Introduction	<b>1-2</b>
1.2 Aircraft	<b>1-3</b>
1.2.1 Airplane gross weight	<b>1-3</b>
1.2.2 Basic dimensions	<b>1-3</b>
1.2.3 Three View Drawings	<b>1-4</b>
1.2.4 Top speed, cruise speed	<b>1-5</b>
1.2.5 Maximum range	<b>1-5</b>
1.2.6 Rate of climb	<b>1-5</b>
1.2.7 Stall speed	<b>1-5</b>
1.3 Fuel capacity	<b>1-6</b>
1.4 Engine power	<b>1-6</b>

TL2000/13/001AJ	Rev. No.: <b>3</b>	Original Issue Date: 6.6.2011 Revision Date: 3.3.2018	<b>1-1</b>
-----------------	--------------------	--	------------

	<b>Pilot's Operating Handbook</b>	Aircraft Type: TL - 2000 Sting S4
		Section 1 - General Information

Notice! The information contained in this document is for reference and information only.  
The pilot is the final and only responsible party for the safe operation of this aircraft.

## 1.1 Introduction

# **READ BEFORE YOUR FIRST FLIGHT!**

### **CAUTION**

**A copy is issued with each aircraft and is required to remain in the aircraft and be available to the pilot at all times.**

### **CAUTION**

**All pilots of this aircraft must read and understand the operation and limitations of this aircraft design.**

As such, many items are added as narrative information to assist them in clearly understanding what is required and in most cases help in achieving the necessary performance. **The POH does not intend to and cannot replace properly qualified ground or in-flight instruction by an certified flight instructor (CFI).**

Maintenance and operation of major components, engine, aircraft parachute system, propeller, avionics or other installed equipment is provided in the appropriate manufacturer manuals which are included with the aircraft. **Any conflicts in this manual should be superseded by the appropriate manufacturer's manual.**

### **CAUTION**

**The Sting S4 is has a high cruising speed and may traverse very different weather conditions during a single flight. The aircraft is designed and intended only for operation in VFR/VMC conditions. The pilot is responsible for the safe flight of the aircraft and should be prepared to avoid any meteorological conditions which will endanger the occupants, the aircraft or both.**

TL2000/13/001AJ	Rev. No.: <b>3</b>	Original Issue Date: 6.6.2011 Revision Date: 3.3.2018	<b>1-2</b>
-----------------	--------------------	--	------------



	<b>Pilot's Operating Handbook</b>	Aircraft Type: TL - 2000 Sting S4
		Section 1 - General Information

Notice! The information contained in this document is for reference and information only.  
The pilot is the final and only responsible party for the safe operation of this aircraft.

## 1.2 Aircraft

The TL-2000 Sting S4 is a full three axis, low wing, two place, side-by-side seating, tricycle landing gear aircraft with a steerable nose wheel. The primary aircraft structure is carbon fiber and fiberglass UV resistant reinforced laminate with an inner foam core creating a 'sandwich' layered construction between each ply.

### 1.2.1 Airplane gross weight

Gross weight: **600 kg** with parachute rescue system

### 1.2.2 Basic dimensions

Length: **6200 mm**  
Cabin width: **1115 mm**  
Wing span: **9120 mm**  
Height: **2050 mm**

#### Areas

Wing: **10,8 m<sup>2</sup>**  
Flap: **0,83 m<sup>2</sup>**  
Aspect ratio: **7.69**  
Glide ratio: **12:1**

TL2000/13/001AJ	Rev. No.: <b>3</b>	Original Issue Date: <b>6.6.2011</b> Revision Date: <b>3.3.2018</b>	<b>1-3</b>
-----------------	--------------------	--	------------

Notice! The information contained in this document is for reference and information only.  
The pilot is the final and only responsible party for the safe operation of this aircraft.

### 1.2.3 Three view drawings

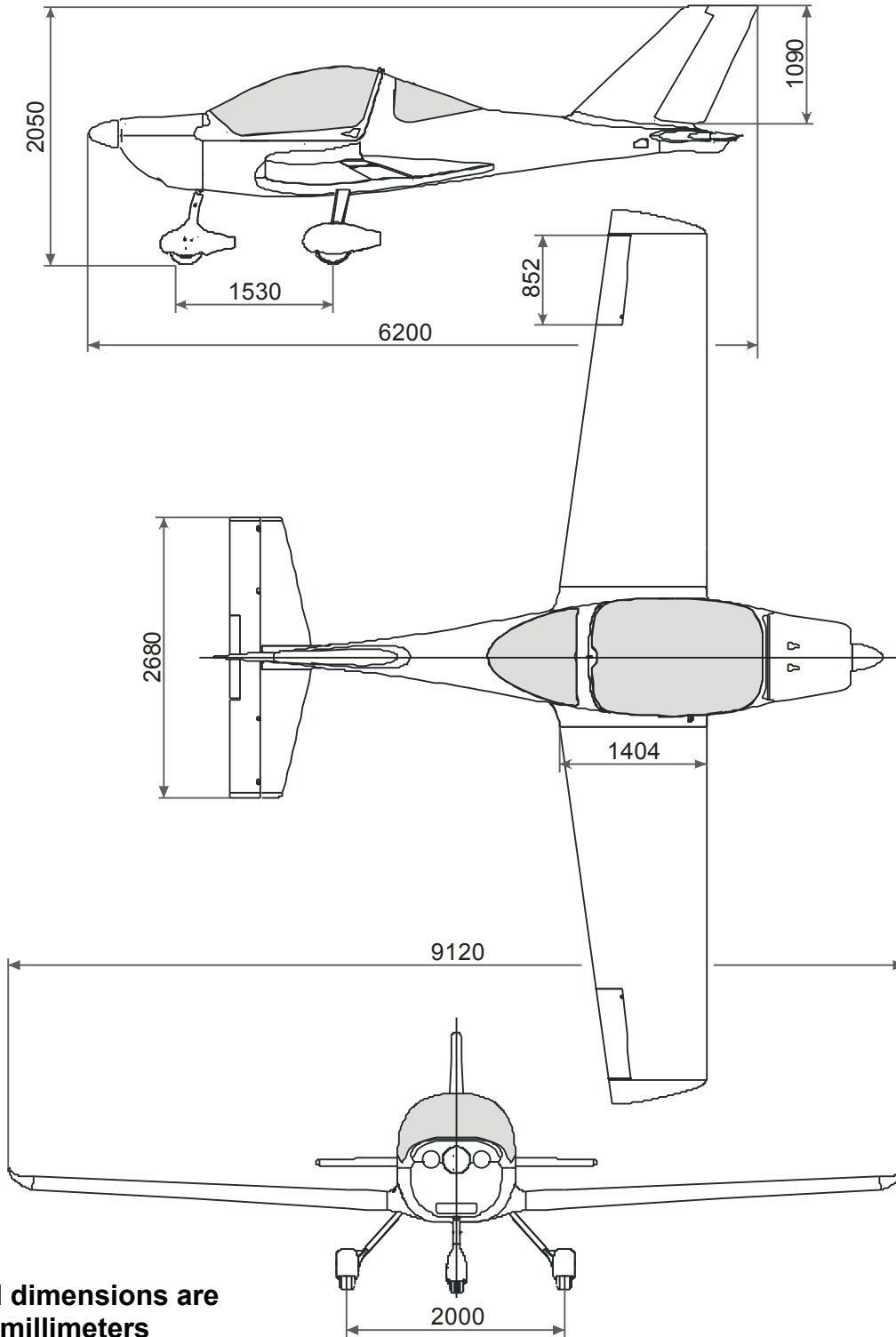

All dimensions are in millimeters

TL2000/13/001AJ	Rev. No.: <b>3</b>	Original Issue Date: 6.6.2011	<b>1-4</b>
		Revision Date: 3.3.2018	

Notice! The information contained in this document is for reference and information only.  
The pilot is the final and only responsible party for the safe operation of this aircraft.

### 1.2.4 Top speed, cruise speed

V	SPEED	KIAS (kts)	REMARKS
V <sub>H</sub>	Maximum sustained speed in level flight	<b>128</b>	Maximum speed with maximum continuous rated engine power in horizontal flight at sea level in standard conditions at full gross weight.

**Speeds shown are for full gross weight at sea level, standard conditions.**

### 1.2.5 Maximum range

Range: **840 km** (No Wind / No Reserve)  
Range (with wing tanks installed): **1370 km** (No Wind / No Reserve)

### NOTE

**Maximum range cannot be obtained at high cruise power settings. For detailed engine data see the Operation manual for ROTAX engine.**

### 1.2.6 Rate of climb

Rate of climb: **5,58 m/s at 130 km/h**, (V<sub>Y</sub>, max power, half flaps)

### 1.2.7 Stall speed

V	SPEED	KIAS (kts)	REMARKS
V <sub>S</sub>	Stall speed (no flaps)	<b>49</b>	Do not attempt to fly slower than this speed at full gross weight when operating without flaps.
V <sub>S0</sub>	Stall speed (full flaps)	<b>43</b>	Do not attempt to fly slower than this speed when operating with full (Landing) flaps.

**Speeds shown are for full gross weight at sea level, standard conditions.**

	<b>Pilot's Operating Handbook</b>	Aircraft Type: TL - 2000 Sting S4
		Section 1 - General Information

Notice! The information contained in this document is for reference and information only.  
The pilot is the final and only responsible party for the safe operation of this aircraft.

### 1.3 Fuel capacity

Total fuselage capacity:	<b>77 l</b>
Wing fuel tanks capacity:	<b>2 x 22 l</b> (if installed)
Total fuel capacity (if wing tanks installed):	<b>121 l</b>
Total unusable:	<b>5,6 l</b>
Approved fuel grade:	<b>91 Unleaded auto gas</b> (yellow)
Alternate fuel grade:	<b>100LL Avgas</b> (blue) (for <i>less</i> than 30% of engine operation time)

### 1.4 Engine power

Horsepower rating and engine speed: **100 BHP at 5800 RPM**

TL2000/13/001AJ	Rev. No.: <b>3</b>	Original Issue Date: <b>6.6.2011</b> Revision Date: <b>3.3.2018</b>	<b>1-6</b>
-----------------	--------------------	--	------------

Notice! The information contained in this document is for reference and information only.  
The pilot is the final and only responsible party for the safe operation of this aircraft.

# 2. LIMITATIONS

## TABLE OF CONTENTS

2.1	Speeds limitation	2-2
2.1.1	Airspeed indicator speed range markings	2-2
2.1.2	Stalling speeds	2-2
2.1.3	Flap extended speed range	2-3
2.1.4	Maneuvering speed	2-3
2.1.5	Never exceed speed	2-3
2.1.6	V – n diagram	2-3
2.2	Service ceiling	2-4
2.3	Load factors limits	2-4
2.4	Maneuver limits	2-4
2.5	Fuel	2-4
2.6	Horsepower rating, engine speed	2-5
2.7	Flight limitations	2-5
2.8	Maximum permissible wind speed	2-6

Notice! The information contained in this document is for reference and information only.  
The pilot is the final and only responsible party for the safe operation of this aircraft.

## 2.1 Speeds limitation

### NOTE

Speeds shown are for full gross weight at sea level, standard conditions.

### 2.1.1 Airspeed indicator speed range markings

MARKING	KIAS (kts)	SIGNIFICANCE
White arc	43 - 65	<b>Full-Flap Operating Range.</b> Lower limit is maximum weight $V_{S0}$ in landing configuration. Upper limit is maximum speed permissible with flaps extended to stage one (Takeoff) (Approach) setting.
Green arc	49 - 118	<b>Normal Operating Range.</b> Lower limit is maximum weight $V_S$ at most forward CG with flaps retracted. Upper limit is maximum structural cruising speed. VCMN
Yellow arc	118 - 153	<b>Caution Range.</b> Operations must be conducted with caution and only in smooth air
Red line	153	<b>Never Exceed Speed.</b> Maximum speed for all operations.

### 2.1.2 Stalling speeds

Stalling speeds at maximum take-off weight.

V	SPEED	KIAS (kts)	REMARKS
$V_S$	Stall speed (no flaps)	49	Do not attempt to fly slower than this speed at full gross weight when operating without flaps.
$V_{S0}$	Stall speed (full flaps)	43	Do not attempt to fly slower than this speed when operating with full (Landing) flaps.

### 2.1.3 Flap extended speed range

V	SPEED	KIAS (kts)	REMARKS
$V_{FE}$	Maximum flap extended speed: Half (takeoff) flaps: Full (landing) flaps:	75 65	Do not exceed these speeds with the given flap settings. Damage to the flap mechanism may occur due to excessive air loads.
$V_{S0}$	Stall speed (full flaps)	43	Do not attempt to fly slower than this speed when operating with full (Landing) flaps.

Notice! The information contained in this document is for reference and information only.  
The pilot is the final and only responsible party for the safe operation of this aircraft.

### 2.1.4 Maneuvering speed

V	SPEED	KIAS (kts)	REMARKS
V <sub>A</sub>	Maneuvering speed	<b>97</b>	Do not make full or abrupt control movements above this speed.

### 2.1.5 Never exceed speed

V	SPEED	KIAS (kts)	REMARKS
V <sub>NE</sub>	Never exceed speed	<b>153</b>	Do not exceed this speed in any operation.

### 2.1.6 V – n diagram

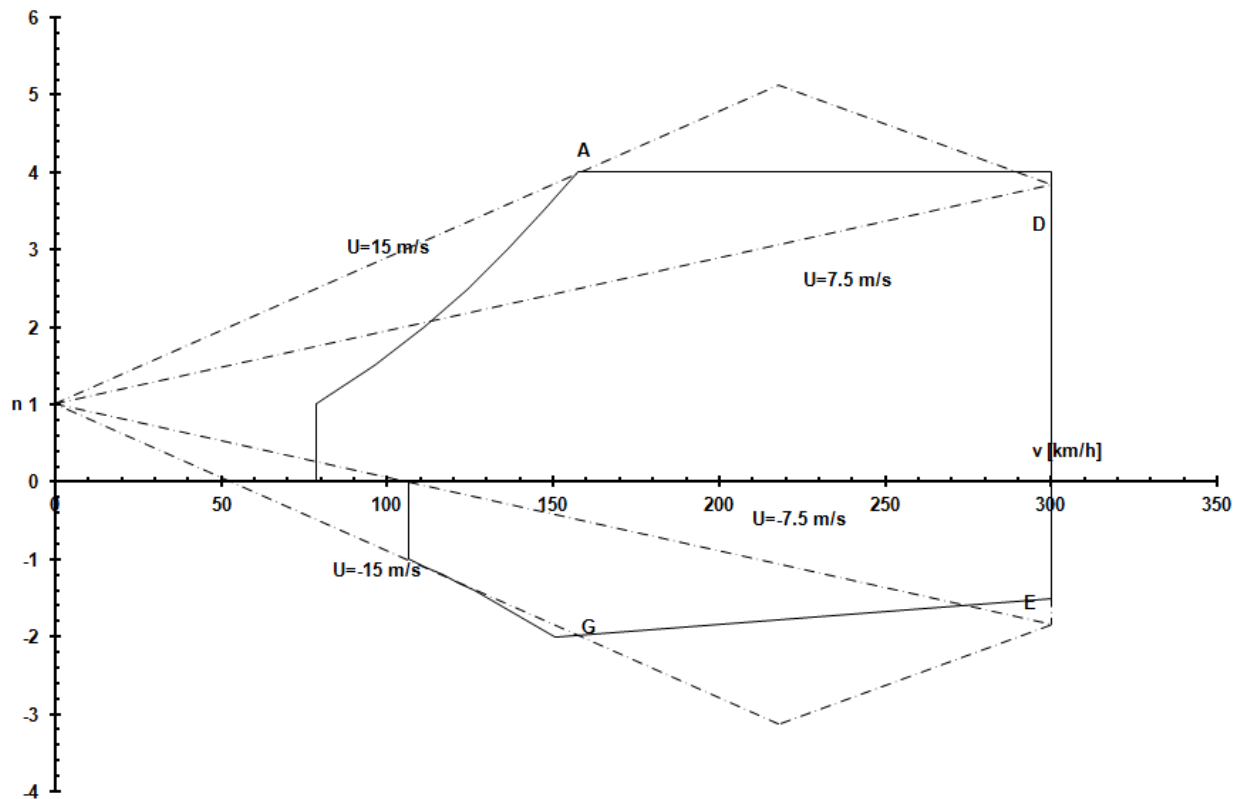

### NOTE

Speeds in V – n diagram are shown in kilometres per hour (kmh).  
 1 kmh = 0,540 kts  
 1 kts = 1,852 kmh

	<b>Pilot's Operating Handbook</b>	Aircraft Type: TL - 2000 Sting S4
		Section 2 - Limitations

Notice! The information contained in this document is for reference and information only.  
The pilot is the final and only responsible party for the safe operation of this aircraft.

## 2.2 Service ceiling

Standard conditions, standard day: **16,000 ft.**  
LSA altitude limits: **10,000 ft. or 2,000 above terrain**

## 2.3 Load factors limits

Flight load factors: **flaps up: +4g, - 2g**  
**flaps down +2g, 0g**

## 2.4 Maneuver limits

This airplane is certified as a Light Sport Aircraft and is not approved for aerobatic flight, including spins. All aerobatic maneuvers, including spins, are prohibited. An aerobatic maneuver, as defined by 14 CFR 91.303, is an intentional maneuver involving an abrupt change in an aircraft's attitude, an abnormal attitude, or abnormal acceleration, not necessary for normal flight.

### WARNING

**All aerobatic maneuvers, including spins, are prohibited.**

## 2.5 Fuel

Total fuselage capacity:	<b>77 l</b>
Wing fuel tanks capacity:	<b>2 x 22 l (if installed)</b>
Total fuel capacity (if wing tanks installed):	<b>121 l</b>
Total unusable:	<b>5,6 l</b>
Fuel consumption:	<b>max. 27 l/h</b>
Approved fuel grade:	<b>91 Unleaded auto gas (yellow)</b>
Alternate fuel grade:	<b>100LL Avgas (blue) (for <i>less</i> than 30% of engine operation time)</b>

### NOTE

**100LL Avgas is to be used as an alternate fuel type if 91 octane auto fuel is not available. Use of 100LL Avgas is restricted to less than 30% of engine operation time by the engine manufacturer. If 91 Octane Unleaded is not available during travel, adding 100LL Avgas in any proportion to partial tanks of 91 Unleaded is acceptable.**

TL2000/13/001AJ	Rev. No.: <b>3</b>	Original Issue Date: 6.6.2011 Revision Date: 3.3.2018	<b>2-4</b>
-----------------	--------------------	--	------------



	<b>Pilot's Operating Handbook</b>	Aircraft Type: TL - 2000 Sting S4
		Section 2 - Limitations

Notice! The information contained in this document is for reference and information only.  
The pilot is the final and only responsible party for the safe operation of this aircraft.

**NOTE**

**It is recommended to avoid fuels that contain ethanol.**

**2.6 Horsepower rating, engine speed**

Horsepower rating and engine speed: **100 BHP at 5800 RPM**

**2.7 Flight limitations**

The Sting S4 is certified for VFR/VMC flight conditions. Operation under IMC conditions is considered an emergency unless the aircraft is so approved.

**NOTE**

**IFR Flight operations do not designate IMC flight conditions.**

TL2000/13/001AJ	Rev. No.: <b>3</b>	Original Issue Date: 6.6.2011 Revision Date: 3.3.2018	<b>2-5</b>
-----------------	--------------------	--	------------

Notice! The information contained in this document is for reference and information only.  
The pilot is the final and only responsible party for the safe operation of this aircraft.

## 2.8 Maximum permissible wind speed

For take off, the maximum permissible wind speed data with vectors can be found in the following diagram:

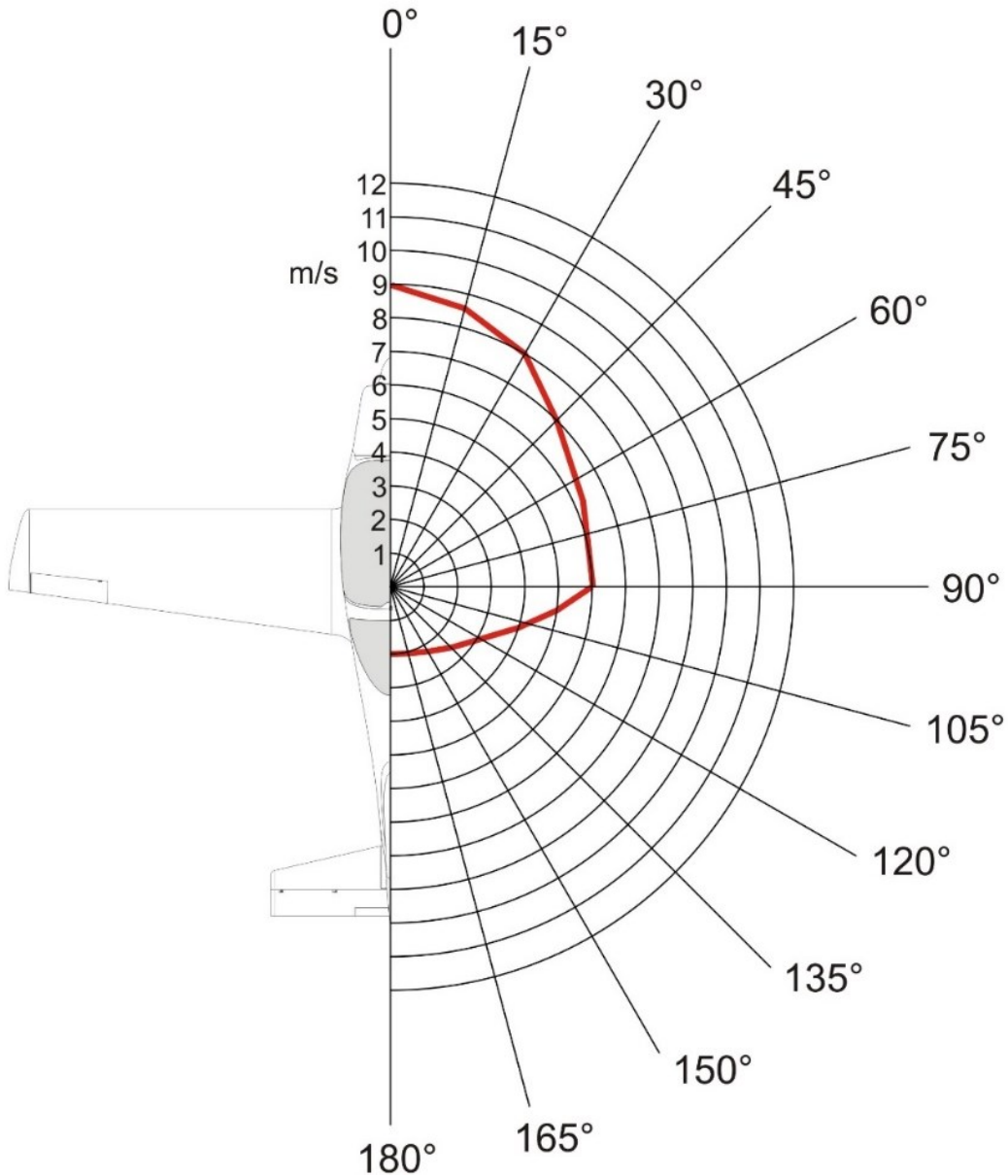

Notice! The information contained in this document is for reference and information only.  
The pilot is the final and only responsible party for the safe operation of this aircraft.

# 3. EMERGENCY PROCEDURES

## TABLE OF CONTENTS

3.1	Emergency speeds	3-2
3.2	Emergency checklists	3-2
3.2.1	Engine fire during start	3-2
3.2.2	Engine failure take-off roll (abort)	3-2
3.2.3	Engine failure (landing) immediately after take-off	3-3
3.2.4	Engine failure during flight	3-3
3.2.5	Emergency landing without engine power	3-3
3.2.6	Precautionary landing with engine power (off airport)	3-4
3.2.7	Engine fire in flight	3-5
3.2.8	Electricity failure	3-6
3.2.9	Inadvertent spiral	3-7
3.2.10	Inadvertent spin	3-8
3.2.11	Low oil pressure or loss of oil pressure	3-8
3.2.12	Exceeding maximum airspeed	3-8
3.3	Aircraft parachute system	3-9
3.3.1	Introducing	3-9

Notice! The information contained in this document is for reference and information only.  
The pilot is the final and only responsible party for the safe operation of this aircraft.

### 3.1 Emergency speeds

Never Exceed Speed: **153 KIAS**  
 Stall Speed (No Flaps): **49 KIAS**  
 Stall Speed (Full Flaps): **43 KIAS**

### 3.2 Emergency checklists

#### 3.2.1 Engine fire during start:

1. Starter.....**CONTINUE CRANKING**
- If engine starts:
2. Power.....**2000 RPM for a few seconds**
3. Fuel valve.....**OFF**
4. Engine.....**SHUTDOWN and INSPECT FOR DAMAGE**
- If engine fails to start:
5. Throttle.....**FULL OPEN**
6. Starter.....**CONTINUE CRANKING**
7. Ignition switches.....**OFF**
8. Fuel valve.....**OFF**
9. Emergency fuel selector.....**(tear off the wire) OFF**
10. Main switch.....**OFF**
11. Fire Extinguisher.....**OBTAIN**
12. Airplane.....**EVACUATE**
13. Fire Extinguisher.....**USE AS REQUIRED**
14. Airplane.....**INSPECT FOR DAMAGE**

#### 3.2.2 Engine failure take-off roll (abort)

1. Throttle.....**IDLE**
2. Brakes.....**APPLY**
3. Wing Flaps.....**RETRACT**

Notice! The information contained in this document is for reference and information only.  
The pilot is the final and only responsible party for the safe operation of this aircraft.

### 3.2.3 Engine failure (landing) immediately after take-off

- |                     |         |
|---------------------|---------|
| 1. Airspeed.....    | 70 KIAS |
| 2. Wing flaps.....  | HALF    |
| 3. Fuel valve.....  | OFF     |
| 4. Main switch..... | OFF     |

### 3.2.4 Engine failure during flight

Engine restart:

- |                           |         |
|---------------------------|---------|
| 1. Airspeed.....          | 70 KIAS |
| 2. Fuel valve.....        | ON      |
| 3. Aux. fuel pump.....    | ON      |
| 4. Ignition switches..... | ON      |
| 5. Starter.....           | ENGAGE  |

If restart fails, execute a forced landing.

### 3.2.5 Emergency landing without engine power

- |                      |                           |
|----------------------|---------------------------|
| 1. Airspeed.....     | 70 KIAS                   |
| 2. Landing zone..... | DETERMINE and FLY TOWARDS |

Engine shutdown:

- |                        |   |
|------------------------|---|
| 3. Aux. fuel pump..... | OFF   |
| 4. Fuel valve.....     | OFF   |
| 5. Radio.....          | SET TO 121.5; TRANSMIT MAYDAY, MAYDAY, MAYDAY!" and AIRCRAFT ID with CURRENT POSITION |
| 6. Transponder.....    | SET TO 7700   |
| 7. Landing zone.....   | CIRCLE OVER (if necessary)  |

Notice! The information contained in this document is for reference and information only.  
The pilot is the final and only responsible party for the safe operation of this aircraft.

- Before landing:
- 8. All switches.....OFF
  - 9. Harnesses.....TIGHTEN
  - 10. Flaps.....FULL (landing is assured)
  - 11. Touchdown.....PREFERABLY INTO WIND, NOSE HIGH
  - 12. Brakes.....APPLY AS REQUIRED

**3.2.6 Precautionary landing with engine power (off airport)**

- 1. Airspeed.....70 KIAS
  - 2. Flaps.....HALF
  - 3. Harnesses.....TIGHTEN
  - 4. Selected field.....EXECUTE LOW PASS (only if practical)
  - 5. Electrical Equipment .....OFF (EXCEPT IGNITION and MAIN SWITCH!)
  - 6. Flaps.....FULL
  - 7. Airspeed.....55 KIAS
  - 8. Touchdown.....PREFERABLY INTO WIND, NOSE HIGH
  - 9. Canopy..... UNLATCH
- CAUTION**
- The canopy may fully open and depart the airframe, if it is unlatched in flight. If the canopy is unlatched, it may be necessary to physically hold it down to prevent it from separating from the airframe.**
- 10. Brake.....APPLY AS REQUIRED

Notice! The information contained in this document is for reference and information only.  
The pilot is the final and only responsible party for the safe operation of this aircraft.

**3.2.7 Engine fire in flight**

**WARNING**

During an in-flight fire do not deploy the aircraft parachute system at high altitude. If the decision is made to use the parachute system and conditions permit, attempt to fly (DIVE) the aircraft to a lower altitude to minimize the time for the fire to spread within the cockpit.

- 1. Fuel valve.....OFF
- 2. Throttle.....FULL OPEN
- 3. Aux. Fuel Pump.....OFF
- 4. Ignition Switches .....OFF
- 5. Cabin heat.....OFF
- 6. Air vents.....AS REQUIRED

**WARNING**

Maintaining approach speed, a low speed side-slip may cause the aircraft to stall and may enter a spin.

- 7. Radio.....SET TO 121.5; TRANSMIT MAYDAY, MAYDAY, MAYDAY!" and AIRCRAFT ID with CURRENT POSITION
- 8. All non-essential switches.....OFF
- 9. Airspeed.....55 KIAS
- 10. Flaps.....FULL
- 11. Force landing.....EXECUTE

Notice! The information contained in this document is for reference and information only.  
The pilot is the final and only responsible party for the safe operation of this aircraft.

### 3.2.8 Electricity failure

#### CAUTION

**If you have during flight any problem with electricity in the airplane, please, use the Emergency engine switch.**

This switch kept switched on only important electrical circuits and fuel pump. Switch is situated on the left side of the central console under the main instrument panel.

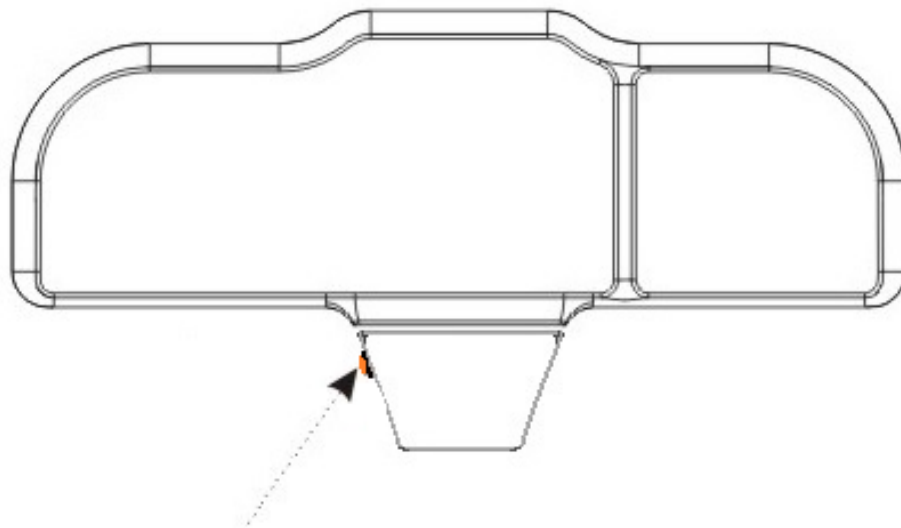



Notice! The information contained in this document is for reference and information only. The pilot is the final and only responsible party for the safe operation of this aircraft.

### 3.2.9 Inadvertent spiral

If a spiral dive is encountered at night or with an inadvertent cloud penetration (IMC/IFR conditions), proceed as follows:

## WARNING

**A spiral dive at night or in instrument meteorological conditions (IMC) is a serious, life threatening emergency. Consider the use of the GRS aircraft parachute system as the primary recovery technique.**

**See Aircraft Parachute system deployment.**

If the aircraft parachute system is not deployed:

1. Airspeed.....**CHECK, IF THE AIRSPEED IS INCREASING**
2. Throttle.....**IDLE**
3. Airspeed.....**CHECK, IF THE AIRSPEED IS DECREASING**
4. Throttle.....**FULL OPEN**
5. **Level the wings using coordinated aileron and rudder until the wings of the attitude reference or turn coordinator are level. Do not attempt to change the nose pitch attitude until the bank indication is level.**
6. **Apply elevator pressure using the attitude reference to maintain wings level until 70 KIAS is established on the airspeed indicator and the altimeter stops moving.**

## CAUTION

**When recovering from a nose-low attitude, do not overstress the airframe by pulling back too abruptly on the flight stick.**

7. **Trim the aircraft to maintain 70 KIAS**
8. **Upon re-entering VFR/VMC conditions, resume normal cruise operation**

Notice! The information contained in this document is for reference and information only.  
The pilot is the final and only responsible party for the safe operation of this aircraft.

### 3.2.10 Inadvertent spin

## WARNING

### Intentional spins in this airplane are prohibited!

Should an inadvertent spin occur in this airplane, the following recovery procedure should be used:

1. Throttle.....IDLE
2. Ailerons.....NEUTRALIZE
3. Rudder.....APPLY FULL (in opposite direction of rotation)
4. Elevator.....FORWARD (to break stall)
5. Rudder.....NEUTRALIZE
6. Elevator.....RECOVER SMOOTHLY FROM NOSE-LOW ATTITUDE

## CAUTION

**Close the throttle to prevent an unnecessary increase in airspeed. During a spin, one wing is in a stalled condition resulting in ineffective aileron inputs to control the rotation. Neutralize the ailerons, and apply full rudder in the opposite direction of rotation. Because an airfoil can stall at any airspeed and in any relation to the horizon, push forward on the stick to break the stall.**

### 3.2.11 Low oil pressure or loss of oil pressure

If a loss of oil pressure is accompanied by a rise in oil temperature, there is good reason to suspect an engine failure may occur. Reduce engine power and select a suitable field for a forced landing. Use only the minimum power required to reach the desired landing zone.

### 3.2.12 Exceeding maximum airspeed

If the aircraft exceeds  $V_{NE} = 153$  KIAS, reduce power and speed immediately. Do not attempt abrupt control movement or unusual attitudes. Continue flight using minimum safe speed and control pressures to land as soon as possible. After landing have the aircraft airworthiness confirmed by a qualified mechanic to return it to service.

Notice! The information contained in this document is for reference and information only.  
The pilot is the final and only responsible party for the safe operation of this aircraft.

### 3.3 Aircraft parachute system

#### 3.3.1 Introducing

The Sting S4 comes standard with an aircraft parachute system manufactured by the Galaxy<sup>®</sup> High Technology (GRS) Corporation. It is imperative that the owner/pilot of this airplane read and understand the system operating manual provided by Galaxy<sup>®</sup>. In most emergency scenarios, the use of the system is not necessary. The parachute system will increase the chance of occupant survival.

### WARNING

**The aircraft parachute system should be considered as the primary method of choice of recovery when the aircraft has departed controlled flight (out of control).**

### WARNING

**When using the parachute rescue system, please take into account that the plane will be destroyed.**

If the system is used, certain steps should at least be attempted prior to activation:

1. Airspeed.....**SLOW THE AIRCRAFT, IF POSSIBLE**
2. Ignition.....**OFF**
3. Harnesses.....**TIGHTEN**
4. Parachute activation handle.....**PULL FIRMLY (approx. 11 kg)**
5. Radio.....**SET TO 121.5; TRANSMIT MAYDAY, MAYDAY, MAYDAY!" and AIRCRAFT ID with CURRENT POSITION**
6. Transponder.....**SET TO 7700**
7. Impact position.....**PULL LIMBS CLOSE TO BODY and COVER FACE**

Firmly pull the parachute activation handle out 18 inches with Force about 11 kilograms. The system should complete inflation in 1.5 – 3.5 seconds.

### WARNING

**Maximum speed for aircraft parachute deployment at gross weight: 120 KIAS.**

Notice! The information contained in this document is for reference and information only.  
The pilot is the final and only responsible party for the safe operation of this aircraft.

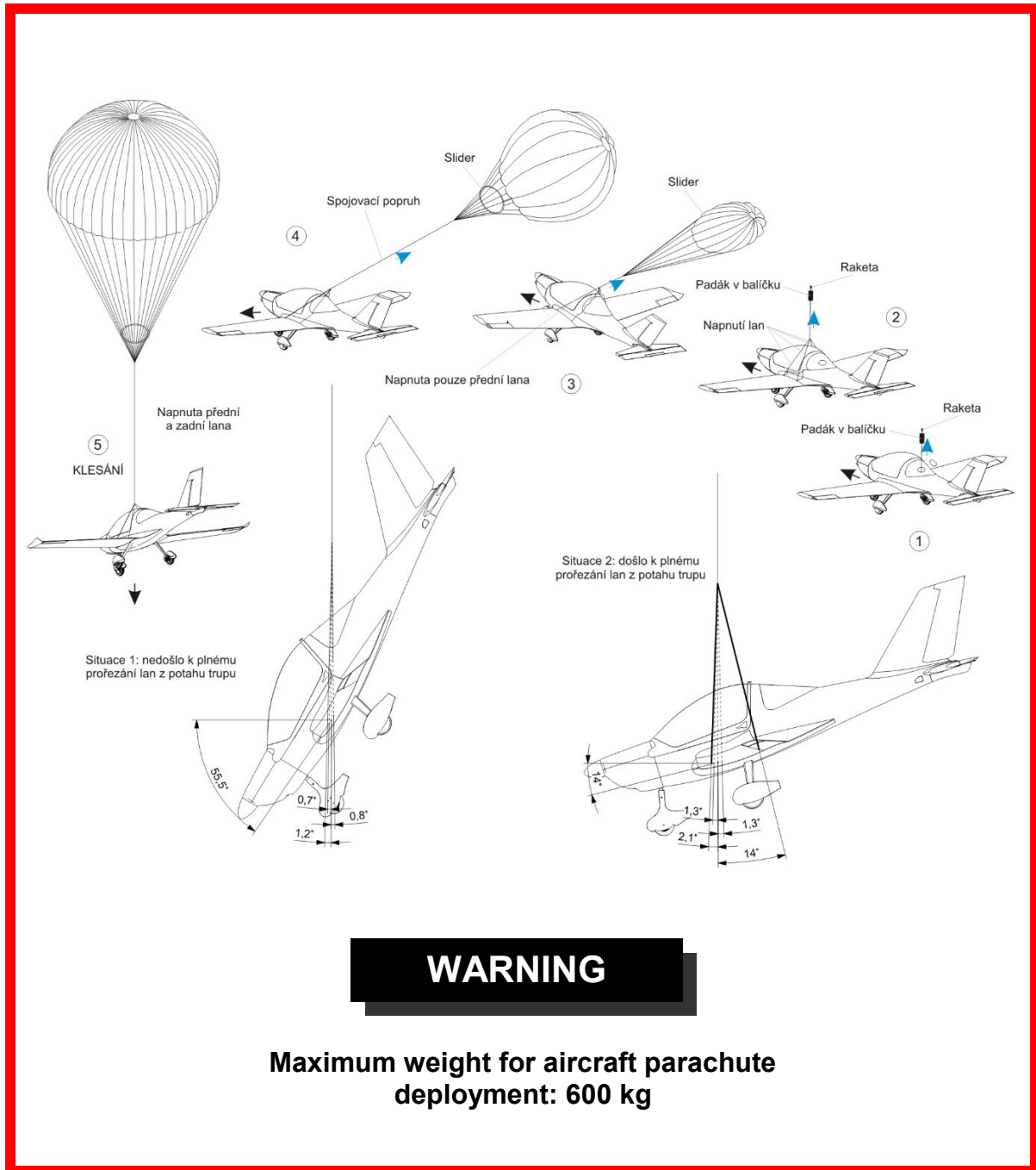

Notice! The information contained in this document is for reference and information only.  
The pilot is the final and only responsible party for the safe operation of this aircraft.

# 4. NORMAL PROCEDURES

## TABLE OF CONTENTS

4.1 Preflight check	<b>4-2</b>
4.1.1 Cockpit	<b>4-2</b>
4.1.2 Exterior checklist	<b>4-2</b>
4.1.2.1 Nose area	<b>4-2</b>
4.1.2.2 Right wing	<b>4-3</b>
4.1.2.3 AFT fuselage	<b>4-3</b>
4.1.2.4 Left wing	<b>4-4</b>
4.2 Operating checklist	<b>4-4</b>
4.2.1 Engine start	<b>4-4</b>
4.2.2 Pre-taxi	<b>4-5</b>
4.2.3 Taxi	<b>4-6</b>
4.2.4 Engine run-up	<b>4-6</b>
4.2.5 Before takeoff	<b>4-6</b>
4.2.6 Takeoff	<b>4-7</b>
4.2.7 Climb	<b>4-7</b>
4.2.7.1 Best angle of climb speed	<b>4-7</b>
4.2.7.2 Best rate of climb speed	<b>4-8</b>
4.2.8 Cruise	<b>4-8</b>
4.2.9 Before landing	<b>4-8</b>
4.2.10 Landing	<b>4-8</b>
4.2.11 Soft field	<b>4-9</b>
4.2.11.1 Soft field take off	<b>4-9</b>
4.2.11.2 Soft field landing	<b>4-9</b>
4.2.12 Balked landing	<b>4-9</b>
4.2.13 After landing	<b>4-9</b>
4.2.14 Shutdown	<b>4-10</b>
4.2.15 Securing the plane	<b>4-10</b>
4.2.16 Canopy manipulation	<b>4-11</b>
4.2.17 Boarding	<b>4-13</b>

Notice! The information contained in this document is for reference and information only.  
The pilot is the final and only responsible party for the safe operation of this aircraft.

## 4.1 Preflight check

### NOTE

**All exterior preflight inspection items, including the cockpit section, can be conducted from outside the airplane.**

### 4.1.1 Cockpit

1. All switches.....OFF
2. Fuel valve.....OFF
3. Main switch.....ON
4. Fuel gauge.....CHECK QUANTITY
5. ELT control panel indicator.....CHECK STATUS
6. Flaps.....PROPER OPERATION
7. Main switch.....OFF
8. Flight controls.....PROPER OPERATION
9. Trim.....CENTERED
10. Required documentation.....ON BOARD
11. Baggage.....SECURED
12. Seats.....SECURE
13. Proceed to exterior checklist

### 4.1.2 Exterior checklist

#### 4.1.2.1 Nose area

1. Windshield.....CLEAN
2. Cowling.....SECURE, screws tight
3. Prop/Spinner.....CHECK
4. Air inlets.....CLEAR
5. Oil.....CHECK QUANTITY
6. Coolant.....CHECK QUANTITY
7. Nose strut assembly.....CHECK
8. Nose tire.....CHECK INFLATION and WEAR
9. Chock.....REMOVE
10. Firewall fuel gascolator.....CHECK for debris and DRAIN,  
CHECK STRAINER in gascolator
11. Fuel and oil tank vents.....CLEAR

Notice! The information contained in this document is for reference and information only.  
The pilot is the final and only responsible party for the safe operation of this aircraft.

- 12. Traffic alert antennae.....**SECURE**
- 13. Transponder antennae.....**SECURE**
- 14. Fuselage fuel pump.....**DRAIN, check for water and contaminates**

**4.1.2.2 Right wing**

- 1. Main fuel tank.....**CHECK QUANTITY / CORRECT FUEL TYPE**
- 2. Main fuel cap.....**SECURE**
- 3. ELT.....**CHECK ARMED AND SECURE**
- 4. Gear leg and brake line.....**CHECK**
- 5. Wheel pant and bracket.....**SECURE**
- 6. Brake pads and disk.....**CHECK FOR WEAR**
- 7. Tire.....**CHECK INFLATION and WEAR**
- 8. Chock.....**REMOVE**
- 9. Wing latitude referencing edge.....**CHECK**
- 10. Wing aux tank (if installed)..**CHECK QUANTITY / FUEL TYPE**
- 11. Wing aux tank cap.....**SECURE**
- 12. Under wing inspection port....**SECURE/CHECK CONTINUITY**
- 13. Pitot tube.....**SECURE – CHECK PITOT / STATIC OPENINGS**
- 14. Tie down strap.....**REMOVE**
- 15. Wing tip cover and enclosed lights.....**CHECK**
- 16. Aileron, tab and hinges.....**CHECK**
- 17. Flap and hinges.....**CHECK**

**4.1.2.3 AFT fuselage**

- 1. Right entry step.....**SECURE**
- 2. Chute window and shroud lines.....**FREE FROM INTERFERENCE**
- 3. VHF antenna.....**SECURE**
- 4. AFT tie down.....**REMOVE**
- 5. Right horizontal stabilizer.....**CHECK**
- 6. Rudder and tab.....**CHECK**
- 7. Elevator, trim tab and hinges.....**CHECK**
- 8. Tail cone control bolts and hinges.....**SECURE / FREE to MOVE**

Notice! The information contained in this document is for reference and information only.  
The pilot is the final and only responsible party for the safe operation of this aircraft.

- 9. Tail cone.....FREE OF DEBRIS
- 10. Left horizontal stabilizer.....CHECK
- 11. AFT inspection cover.....SECURE
- 12. AFT strobe and position light.....CHECK
- 13. Left entry step.....SECURE

#### 4.1.2.4 Left wing

- 1. Flap and hinges.....CHECK
- 2. Aileron and hinges.....CHECK
- 3. Wing tip cover and enclosed lights.....CHECK
- 4. Tie down strap.....REMOVE
- 5. Wing latitude referencing edge.....CHECK
- 6. Under wing inspection ports.....SECURE / CHECK  
CONTINUITY
- 7. Wing aux tank (if installed).....CHECKT QUANTITY / FUEL  
TYPE
- 8. Wing aux tank cap.....SECURE
- 9. Gear leg and brake line.....CHECK
- 10. Wheel pant and bracket.....SECURE
- 11. Brake pads and disk.....CHECK FOR WEAR
- 12. Tire.....CHECK INFLATION and WEAR
- 13. Chock.....REMOVE

## 4.2 Operating checklist

### 4.2.1 Engine start

- 1. Canopy.....CLOSED and LOCKED
- 2. Harnesses.....ADJUST and FASTEN
- 3. Headsets.....ON and ADJUST
- 4. All switches.....OFF
- 5. Fuel valve.....ON
- 6. Throttle.....IDLE
- 7. Main switch.....ON



Notice! The information contained in this document is for reference and information only.  
The pilot is the final and only responsible party for the safe operation of this aircraft.

- 8. Aux fuel pump.....**MOMENTARILY ON**
- 9. Aux fuel pump.....**OFF**
- 10. Ignition switches.....**ON**
- 11. Check area visually and call out.....**"CLEAR PROP!"**

**CAUTION**

**Call out "CLEAR PROP!" through the canopy vent window. Also use a visual signal by rotating your hand vertically with an index finger up to indicate propeller movement. This step is intentionally some steps ahead of the starter engagement to allow time for the nearby personnel to clear the propeller movement area.**

- 12. Brakes.....**HOLD**
- 13. Choke.....**AS REQUIRED**
- 14. Starter.....**ENGAGE**
- 15. Throttle.....**2000 RPM**
- 16. Oil pressure.....**CHECK**
- 17. Choke.....**CLOSED as engine warms**
- 18. Instrument switch.....**ON**
- 19. Strobe lights.....**ON**
- 20. Intercom.....**ON**
- 21. Flaps.....**HALF**

**4.2.2 Pre-taxi**

- 1. Oil pressure.....**CHECK**
- 2. Transponder.....**STANDBY**
- 3. VHF.....**ON**
- 4. GPS.....**ON**
- 5. Other avionics.....**ON**
- 6. Turn coordinator.....**LEVEL**
- 7. Altimeter.....**SET (note any field elevation variance)**
- 8. Parachute resc. syst. – safety pin.....**MOVED and STOWED**
- 9. Warm-up.....**AS REQUIRED**

Notice! The information contained in this document is for reference and information only.  
The pilot is the final and only responsible party for the safe operation of this aircraft.

**4.2.3 Taxi**

- 1. Area.....CLEAR
- 2. Brakes.....CHECK and APPLY AS NEEDED
- 3. Steering.....CHECK
- 4. Compass.....CHECK
- 5. Attitude reference track display .....CHECK
- 6. Turn coordinator.....CHECK (in turns)

**WARNING**

Breaking and systematically applied brakes could decrease the brake affectivity due to the hydraulic liquid overheating.

**4.2.4 Engine run-up**

- 1. Brakes.....HOLD
- 2. Oil temperature.....50°C min
- 3. Oil pressure.....29 – 73 PSI
- 4. Cylinder head temperature.....50°C min
- 5. Throttle.....4000 RPM
- 6. Ignition switches.....300 RPM DROP (max)  
120 RPM DIFF (max)
- 7. Throttle.....2000 RPM
- 8. Fuel pressure.....CHECK

**WARNING**

If you inadvertently switch off both ignitions at high RPM, do not turn the switches back on. Allow the engine to come to a stop and restart the engine.

**4.2.5 Before takeoff**

- 1. Harnesses.....SECURE
- 2. Loose items.....SECURE
- 3. Instruments.....CHECK and SET
- 4. EMS data.....CHECK
- 5. VHF attitude reference.....SET
- 6. Transponder.....ON / ALT
- 7. Trim.....AFT

Notice! The information contained in this document is for reference and information only.  
The pilot is the final and only responsible party for the safe operation of this aircraft.

- 8. Controls.....FREE and CORRECT MOVEMENT
- 9. Canopy.....LOCKED (3x)
- 10. Parachute rescue system - safety pin...CHECK REMOVED
- 11. Aux fuel pump.....AS REQUIRED

**WARNING**

Operation of both the engine driven and the auxiliary fuel pump for take-off and landing is not recommended.

4.2.6 Takeoff

- 1. Flaps.....CHECK (HALF)
- 2. Throttle.....FULL
- 3. Rotate.....45 KIAS
- 4. Throttle.....MONITOR (5800 RPM maximum)
- 5. Climb.....75 KIAS
- 6. Flaps.....RETRACT SMOOTHLY AT 500 AGL

4.2.7 Climb

- 1. Throttle.....SET TO 5500 RPM (or as required)
- 2. Climb.....75 KIAS
- 3. Trim.....ADJUST AS NEEDED
- 4. EMS data.....CHECK
- 5. Aux Fuel Pump.....OFF (if used)

4.2.7.1 Best angle of climb speed

Best angle of climb speed ( $V_x$ ) is **50 KIAS**.

Notice! The information contained in this document is for reference and information only.  
The pilot is the final and only responsible party for the safe operation of this aircraft.

#### 4.2.7.2 Best rate of climb speed

Best rate of climb speed (Vy) is **55 KIAS**.

#### 4.2.8 Cruise

- |                     |                  |
|---------------------|------------------|
| 1. Throttle.....    | 5000 TO 5200 RPM |
| 2. Trim.....        | LEVEL FLIGHT     |
| 3. Fuel status..... | MONITOR          |
| 4. EMS data.....    | CHECK            |

#### 4.2.9 Before landing

- |                       |                |
|-----------------------|----------------|
| 1. Harnesses.....     | SECURE         |
| 2. Airspeed.....      | 70 KIAS        |
| 3. Fuel.....          | CHECK QUANTITY |
| 4. Secure loose items |                |
| 5. Aux Fuel Pump..... | AS REQUIRED    |

#### 4.2.10 Landing

- |                    |                             |
|--------------------|-----------------------------|
| On downwind leg:   |                             |
| 1. Throttle.....   | SMOOTHLY TO IDLE            |
| 2. Airspeed.....   | 75 KIAS                     |
| 3. Flaps.....      | HALF                        |
| On base leg:       |                             |
| 4. Airspeed.....   | 65 KIAS                     |
| 5. Trim.....       | ADJUST TO AFT               |
| On final approach: |                             |
| 6. Airspeed.....   | 55 KIAS                     |
| 7. Flaps.....      | FULL                        |
| 8. Trim.....       | AFT AS REEQUIRED            |
| 9. Throttle.....   | IDLE (or as required)       |
| 10. Airspeed.....  | 55 KIAS (on short final)    |
| 11. Touchdown..... | MAIN WHEEL FIRST, NOSE HIGH |
| 12. Braking.....   | MINIMUM                     |

Notice! The information contained in this document is for reference and information only.  
The pilot is the final and only responsible party for the safe operation of this aircraft.

#### 4.2.11 Soft field

##### 4.2.11.1 Soft field take off

When taxiing over soft ground, keep constant back pressure on the flight stick to relieve stress on the nose strut. Set Half flaps before entering the runway. Maintain elevator back pressure, and when clear for takeoff, add enough power to just get the airplane moving. As the airplane accelerates, smoothly add full power. As airspeed increases, raise the nose wheel off the ground, and when the airplane becomes airborne, level the nose to remain in ground effect until  $V_x$  is reached and accelerate to  $V_y$ . When  $V_y$  has been established, continue on a normal climb-out.

##### 4.2.11.2 Soft field landing

The only difference between a normal landing and a soft field landing is keeping the nose wheel off the runway surface for as long as possible. To do this, float down the runway in ground effect rather than flaring to bleed off airspeed. This will decrease the sink rate to help prevent a hard landing. As the airspeed slows, flare just slightly enough to raise the nose wheel, but do not establish a high sink rate. Allow the airplane to settle to the runway, roll, and as the airplane decelerates, allow the nose wheel to gently settle. Do not allow the nose wheel to touch down on landing. This could result in the nose wheel digging into the soft runway and loss of airplane control. Continue the landing to the ground. Use as little braking as necessary throughout the entire landing and taxi.

#### 4.2.12 Balked (go around) landing

- |                  |                                 |
|------------------|---------------------------------|
| 1. Throttle..... | FULL                            |
| 2. Flaps.....    | SET TO HALF                     |
| 3. Airspeed..... | 50 KIAS, $V_x$                  |
| 4. Flaps.....    | RETRACT WHEN CLEAR OF OBSTACLES |
| 5. Airspeed..... | 55 KIAS, $V_y$                  |

#### 4.2.13 After landing

- |                       |               |
|-----------------------|---------------|
| 1. Flaps.....         | UP            |
| 2. Aux fuel pump..... | OFF (if used) |
| 3. Transponder.....   | STANDBY       |

Notice! The information contained in this document is for reference and information only.  
The pilot is the final and only responsible party for the safe operation of this aircraft.

#### 4.2.14 Shutdown

<ol style="list-style-type: none"> <li>1. Throttle.....IDLE</li> <li>2. GPS.....OFF</li> <li>3. Transponder.....OFF</li> <li>4. Other avionics.....OFF</li> <li>5. Strobes.....OFF</li> <li>6. All switch.....OFF (except MAIN SWITCH and IGNITION)</li> </ol> <p style="text-align: center;"><b>WARNING</b></p> <p><b><u>If the main switch is turned off now, the engine can not be turned off.</u></b></p> <ol style="list-style-type: none"> <li>7. Ignition switches.....OFF (one at time)</li> <li>8. Main switch.....OFF</li> <li>9. Fuel valve.....CLOSE (horizontal)</li> <li>10. GRS safety pin.....INSERT</li> <li>11. Canopy.....OPEN</li> </ol> <p style="text-align: center;"><b>WARNING</b></p> <p style="text-align: center;"><b>It is imperative that the GRS safety pin be reinserted into its respective locking position before the crew and passenger disembark the airplane in order to prevent an accidental firing of the rocket system.</b></p>
--

#### 4.2.15 Securing the plane

<ol style="list-style-type: none"> <li>1. Vents.....CLOSED and TURNED DOWN</li> <li>2. Canopy.....CLOSED and LOCKED</li> <li>3. Wheels.....CHOCK</li> <li>4. Tie downs.....SECURE</li> <li>5. Pitot cover.....ON if required</li> <li>6. Aircraft cover.....AS REQUIRED</li> </ol>
--

	<b>Pilot's Operating Handbook</b>	Aircraft Type: TL - 2000 Sting S4
		Section 4 - Normal Procedures

Notice! The information contained in this document is for reference and information only.  
The pilot is the final and only responsible party for the safe operation of this aircraft.

#### 4.2.16 Canopy manipulation

The TL 2000 Sting S4 Aircraft is equipped with a forward tilting canopy which enables comfortable access for the crew. The canopy in its closed position is secured at three points (locks). Only complete securing at all three points will ensure full locking of the canopy and safeguarding against opening during flight. When closing the canopy prior to flight, it is necessary to proceed as follows:

1. **Inspect that all canopy contact surfaces are clear and remove any objects that could prevent proper canopy closing (clothes, safety belts, headset cables, etc.)**
2. **Pull down the canopy using the upper section handle all the way until the central mechanism clicks**
3. **Secure the canopy in its closed position by rotating (forward) the pair of handles located on each side of the canopy**

### CAUTION

**Should any form of resistance occur in the canopy closing mechanisms, do not attempt to close the canopy by force. Damage to the lock mechanisms could occur. Open the canopy again, inspect the contact surfaces for presence of foreign objects preventing proper closing of the canopy.**

### CAUTION

**With the aircraft on the ground, do not leave the canopy in the opened position. Damage to the canopy can occur due to sudden wind gusts or the above instrument panel upholstery could sustain damage due to excess localized heat caused by a magnifying effect from the transparent part of the opened canopy.**

TL2000/13/001AJ	Rev. No.: <b>3</b>	Original Issue Date: 6.6.2011 Revision Date: 3.3.2018	<b>4-11</b>
-----------------	--------------------	--	-------------

Notice! The information contained in this document is for reference and information only.  
The pilot is the final and only responsible party for the safe operation of this aircraft.

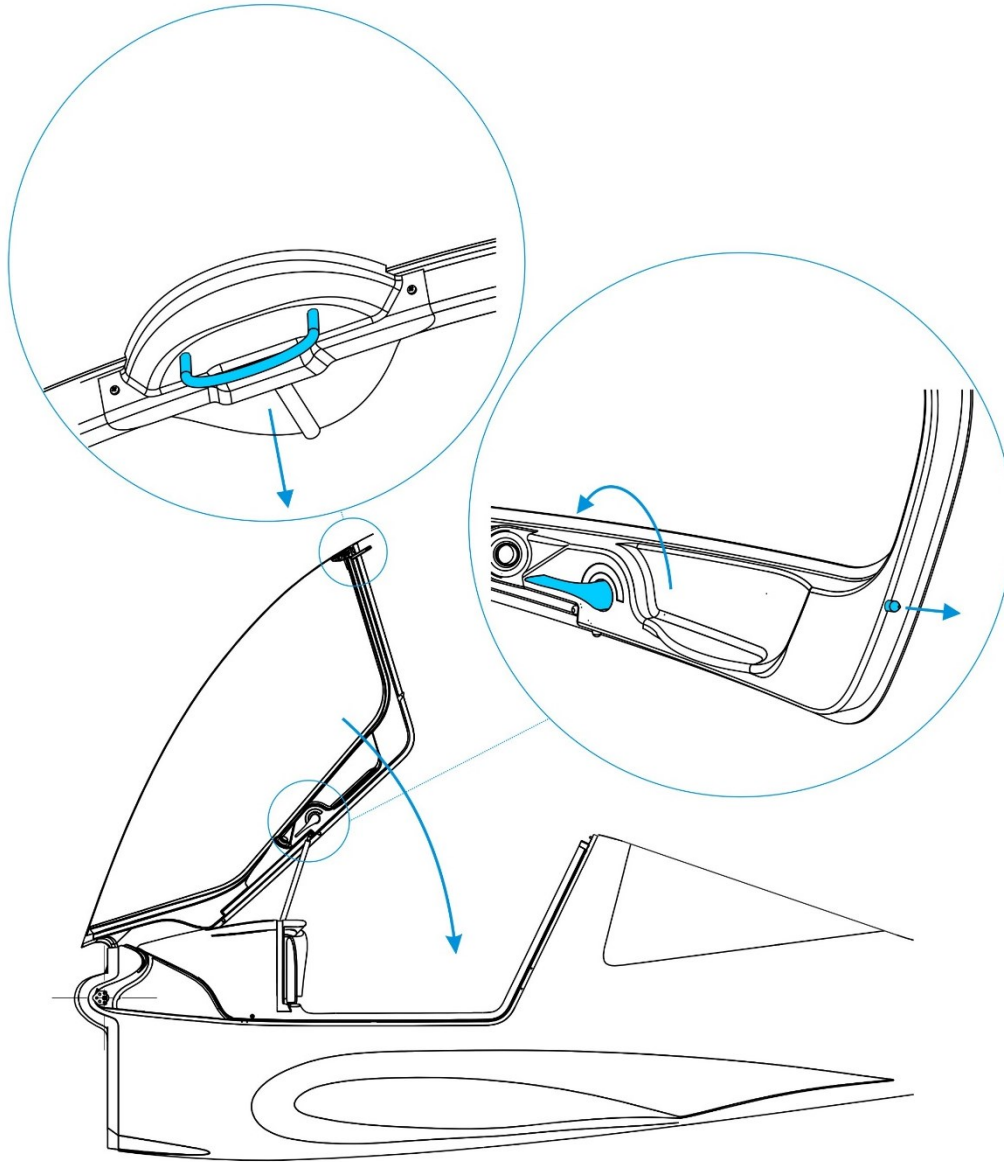

**CAUTION**

**It is always necessary to close the canopy when the aircraft stands out of hangar in the direct sun. By open canopy there is a danger of burn-out of instrument panel cover.**



	<b>Pilot's Operating Handbook</b>	Aircraft Type: TL - 2000 Sting S4
		Section 4 - Normal Procedures

Notice! The information contained in this document is for reference and information only.  
The pilot is the final and only responsible party for the safe operation of this aircraft.

#### 4.2.17 Boarding

### CAUTION

**Boarding the plane individually one by one.  
Otherwise, you can roll over or damage the aircraft.**

TL2000/13/001AJ	Rev. No.: <b>3</b>	Original Issue Date: 6.6.2011 Revision Date: 3.3.2018	<b>4-13</b>
-----------------	--------------------	--	-------------

	<b>Pilot's Operating Handbook</b>	Aircraft Type: TL - 2000 Sting S4
		Section 5 - Performance

Notice! The information contained in this document is for reference and information only.  
The pilot is the final and only responsible party for the safe operation of this aircraft.

# 5. PERFORMANCE

## TABLE OF CONTENTS

5.1	Take off distances	<b>5-2</b>
5.2	Rate of climb	<b>5-2</b>
5.3	Cruise speed	<b>5-2</b>
5.4	Fuel consumption	<b>5-2</b>
5.5	Landing distances	<b>5-2</b>
5.6	Airspeed indication system error correction (km/h)	<b>5-3</b>

TL2000/13/001AJ	Rev. No.: <b>3</b>	Original Issue Date: <b>6.6.2011</b> Revision Date: <b>3.3.2018</b>	<b>5-1</b>
-----------------	--------------------	--	------------

	<b>Pilot's Operating Handbook</b>	Aircraft Type: TL - 2000 Sting S4
		Section 5 - Performance

Notice! The information contained in this document is for reference and information only.  
The pilot is the final and only responsible party for the safe operation of this aircraft.

## 5.1 Take off distances

Takeoff roll distance: **160 m** max power, half flaps, paved RWY  
 Takeoff distance over a 50ft obstacle: **275 m**, max power, half flaps, paved RWY

## 5.2 Rate of climb

Rate of climb: **810 ft/min at 55 KIAS**,  $V_Y$ , max power, half flaps

## 5.3 Cruise speed

Design cruise speed: **95 – 122 KIAS**  
 Maximum cruise speed: **122 KIAS** ( $V_H$ , max continuous power)

## 5.4 Fuel consumption

Maximum power: **26,1 l/h** (Fuel flow at cruise altitude will be less)  
 Maximum continuous power: **23,6 l/h** (Fuel flow at cruise altitude will be less)  
 75% continuous power: **16,5 l/h** (Fuel flow at cruise altitude will be less)

### NOTE

For more information see the Operation manual for ROTAX engine.

## 5.5 Landing distances

Landing roll with braking (50ft obstacle): **285 m**, heavy braking, dry paved RWY  
 Landing roll without braking (50ft obstacle): **275 m**, no braking, dry paved RWY

TL2000/13/001AJ	Rev. No.: <b>3</b>	Original Issue Date: <b>6.6.2011</b> Revision Date: <b>3.3.2018</b>	<b>5-2</b>
-----------------	--------------------	--	------------

Notice! The information contained in this document is for reference and information only.  
The pilot is the final and only responsible party for the safe operation of this aircraft.

## 5.6 Airspeed indication system error correction (km/h)

### NOTE

**All speeds are shown in kilometres per hour (kmh).**

**1 kmh = 0,540 kts**

**1 kts = 1,852 kmh**

IAS (km/h)	CAS (km/h)		
	Cruising configuration	Take-off configuration	Landing configuration
70		67	65
80		74	73
90	84	81	82
100	93	90	90
110	102	99	99
120	111	108	108
130	121	119	117
140	130	130	
150	139		
160	149		
170	158		
180	168		
190	177		
200	187		
210	196		
220	206		
230	216		
240	225		
250	235		
260	245		
270	255		
280	264		
290	274		
300	284		

Notice! The information contained in this document is for reference and information only.  
The pilot is the final and only responsible party for the safe operation of this aircraft.

# 6. WEIGHT, BALANCE AND EQUIPMENT LIST

## TABLE OF CONTENTS

6.1	Equipment list for a standard equipped aircraft	<b>6-2</b>
6.2	List of additional installed equipment	<b>6-2</b>
6.3	Auxiliary items	<b>6-2</b>
6.4	Weigh & balance	<b>6-3</b>
6.4.1	Procedure	<b>6-3</b>
6.4.2	Forward center of gravity calculations	<b>6-4</b>
6.4.3	Rear center of gravity calculations	<b>6-5</b>
6.4.4	Horizontal distance from datum plane	<b>6-6</b>

	<b>Pilot's Operating Handbook</b>	Aircraft Type: TL - 2000 Sting S4
		Section 6 - Weight and Balance

Notice! The information contained in this document is for reference and information only.  
The pilot is the final and only responsible party for the safe operation of this aircraft.

## 6.1 Equipment list for a standard equipped aircraft

- ATTITUDE INDICATOR & TRACK DISPLAY & ANTENNA (ADI)
- AIRSPEED INDICATOR (ASI)
- ALTIMETER (ALT)
- AUTO PILOT SYSTEM MOUNTING BRACKETS
- AUXILIARY 12V POWER PORT (2)
- AUXILIARY 12V EXTERNAL POWER CONNECTION
- AUXILIARY ENGINE FUEL PUMP (AUX)
- AUXILIARY WING FUEL TANKS, FILTER & PUMP (If Installed)
- CABIN HEAT SYSTEM
- ELECTRIC FLAPS DRIVE
- EMERGENCY LOCATOR TRANSMITTER & AIRCRAFT ANTENNA (ELT)
- EMERGENCY LOCATOR TRANSMITTER PORTABLE ANTENNA
- EMERGENCY LOCATOR TRANSMITTER REMOTE CONTROL DISPLAY
- ENGINE INFORMATION SYSTEM & SENSORS (EMS)
- ENGINE CARBURETOR HEAT SYSTEM
- FIRE EXTINGUISHER
- FUEL GAUGE (FG)
- FUEL SHUT-OFF VALVE
- GLOBAL POSITIONING SYSTEM RECEIVER & ANTENNA (GPS)
- GROUND ADJUSTABLE PROPELLER
- HOBBS METER (HOBBS)
- INTERCOM SYSTEM
- LANDING & TAXI LIGHTS
- MAGNETIC COMPASS (MC)
- POSITION LIGHTS
- PARACHUTE SYSTEM (GRS)
- ROTAX RPM TACHOMETER (TACH) (RPM)
- 4POINT SAFETY HARNESSSES (2)
- SLIP SKID INDICATOR
- STROBE LIGHTS (3)
- TRANSPONDER & ANTENNA (XPDR)
- TRANSPONDER MODE C ENCODER (MODE C)
- TURN COORDINATOR (TC)
- VERTICAL SPEED INDICATOR (VSI), (VVI)
- VHF COMMUNICATION RADIO & ANTENNA (VHF), (COM1)

TL2000/13/001AJ	Rev. No.: <b>3</b>	Original Issue Date: 6.6.2011 Revision Date: 3.3.2018	<b>6-2</b>
-----------------	--------------------	--	------------

Notice! The information contained in this document is for reference and information only.  
The pilot is the final and only responsible party for the safe operation of this aircraft.

## 6.2 List of additional installed equipment

List of additional installed equipment (add to above)
1.
2.
3.
4.
5.

## 6.3 Auxiliary items

- COCKPIT COVER (if purchased)
- EQUIPMENT INFO & DATA MANUALS
- EXTRA KEY
- ROTAX ENGINE DATA CD
- MISCELLANIOUS TOOLS & SUPPLIES

## 6.4 Weigh & balance

It is the pilot's responsibility to make sure the weight and balance limits are not exceeded as to weight, its location, distribution and security prior to any flight.

### 6.4.1 Procedure

All permanent equipment, options, and accessories should be installed on the aircraft prior to weighing. All equipment options and accessories installed in the aircraft must be listed on the "Installed Equipment List". That list becomes part of Weight and Balance Documents.

Be sure to remove any loose equipment, tools, etc. from the aircraft prior to weighing.

Sometimes it is necessary to adjust or reduce fuel, cargo, or passenger weights to remain at or below Maximum Allowable Gross Weight. Temporary or permanent ballast is sometimes necessary to bring the CG within specified limits. However, the Maximum Allowable Gross Weight should not be exceeded under any circumstances

The fuel tank should be empty except for unusable fuel. If the fuel tank is not empty, then the exact amount of usable fuel in the tank must be determined. Usable fuel weight and its moment must be deducted from the Empty Weight calculations before EWCG can be accurately determined.

Notice! The information contained in this document is for reference and information only.  
The pilot is the final and only responsible party for the safe operation of this aircraft.

Oil and coolant tanks and reservoirs must be properly filled before weighing. These and any other liquids necessary for normal operations are considered part of an aircraft's empty weight.

For best results, weigh indoors. The scales must be calibrated correctly and must be set on level ground.

Any equipment placed on the scales when weighing the aircraft, such as chocks or blocks, should be weighed separately and the weight deducted from the scale reading.

Weight & balance data worksheet notes	
<b>Datum Plane:</b>	Axis of the nose wheel.
<b>Maximum Forward CG Limit:</b>	1211,5 mm aft of Datum (24%)
<b>Maximum Aft CG Limit:</b>	1321,6 mm aft of Datum (33%)
<b>Maximum Gross Weight:</b>	600 kg
<b>Maximum Seat Load:</b>	90 kg
<b>Minimum Pilot Weight:</b>	50 kg
<b>Maximum Main Fuel:</b>	55 kg
<b>Maximum Wing Fuel:</b>	35 kg (in installed)
<b>Maximum Baggage Weight:</b>	25 kg

**Centre of gravity positioning permitted range (% MAC): 24 – 33%**  
**MAC: 1223 mm**

The aircraft must be weighed in a level flight attitude, both longitudinally (front to back) and laterally, as shown in the as shown in the Moment Arm Drawing Data Sheet. Pictures page 6-6.

Place a scale under each wheel of aircraft. If only one scale is used, be sure to level the wheels not being weighed before taking the scale readings. Remember, the aircraft must be in proper level flight attitude to ensure accuracy. Tab page 6-7.

#### 6.4.2 Forward center of gravity calculations

- on the pilot seat place 50 kg (minimum pilot weight)
- in airplane there must not be any baggage, main fuel tank must be full, wing tanks must be empty
- on the scales under the main undercarriage legs read weight on the main wheels  $G_p$



	<b>Pilot's Operating Handbook</b>	Aircraft Type: TL - 2000 Sting S4
		Section 6 - Weight and Balance

Notice! The information contained in this document is for reference and information only.  
The pilot is the final and only responsible party for the safe operation of this aircraft.

- on the scale under the nose leg see weight on the front wheel  $G_o$
- the total gross weight  $G_{vzl}$  calculate as  $G_{vzl} = G_p + G_o$
- distance from nose wheel axis to main wheel axis is  $L_b = 1530 \text{ mm}$
- distance from wing leading edge to main wheel axis  $L_a = 617 \text{ mm}$
- calculate vertical distance from aircraft center of gravity to main wheel axis  $L_t$  according formula:

$$L_t = \frac{G_o \cdot L_b}{G_{vzl}}$$

- start of the MAX from the leading edge of the wing is 5 mm
- calculate distance from aircraft center of gravity to wing leading edge  $X_t$  according formula:

$$X_t = L_a - L_t - 5$$

- calculate forward center of gravity in percentage according formula:

$$X_{\%} = \frac{X_t}{SAT} \cdot 100$$

**- permitted value of forward center of gravity is 24%**

**6.4.3 Rear center of gravity calculations**

- empty main fuel tank in the fuselage and wing tanks
- to the baggage compartment place max. baggage weight – 25 kg
- the rest of the weight in max. gross weight (600 kg with parachute rescue system) –
- place on the pilot seats (max. 90 kg load on seat)

The calculation procedure is the same as “ 6.4.2 Forward center of gravity calculations

**- permitted value of rear center of gravity is 33%**

TL2000/13/001AJ	Rev. No.: <b>3</b>	Original Issue Date: 6.6.2011 Revision Date: 3.3.2018	<b>6-5</b>
-----------------	--------------------	--	------------

Notice! The information contained in this document is for reference and information only.  
The pilot is the final and only responsible party for the safe operation of this aircraft.

### 6.4.4 Horizontal distance from datum plane

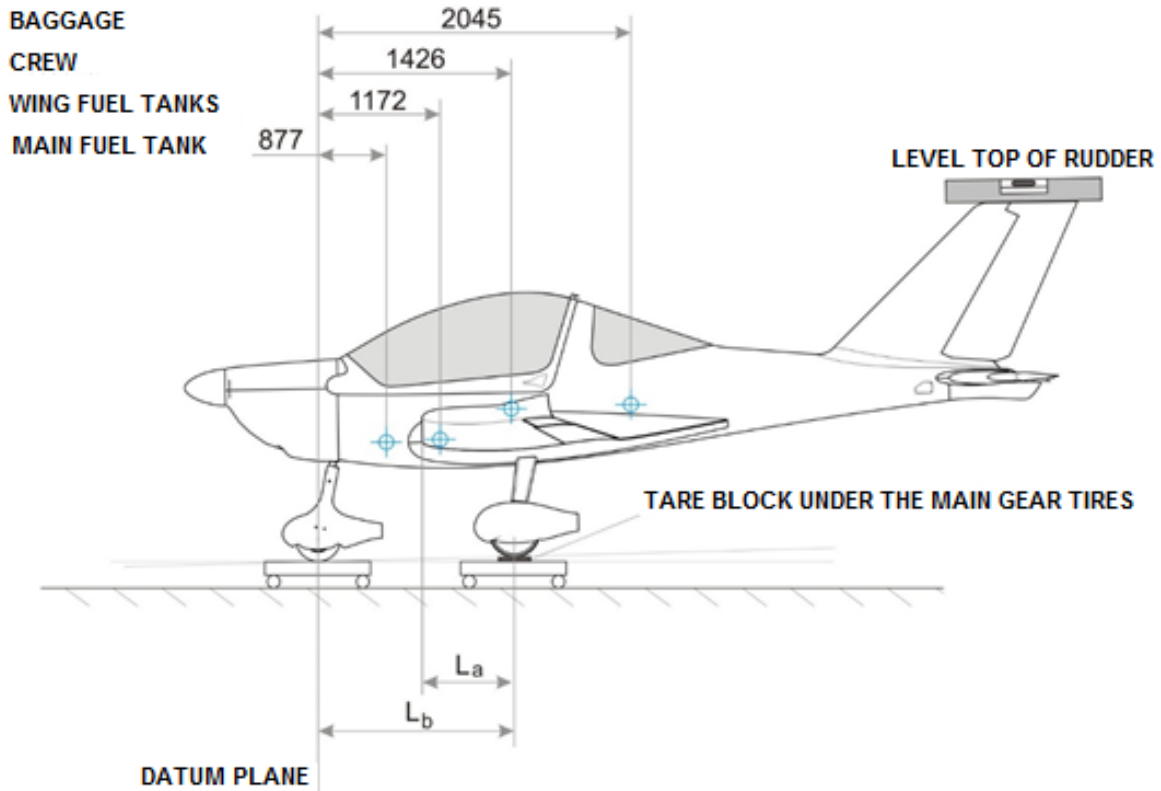

	<b>Pilot's Operating Handbook</b>	Aircraft Type: TL - 2000 Sting S4
		Section 7 - Description of Airplane

Notice! The information contained in this document is for reference and information only.  
The pilot is the final and only responsible party for the safe operation of this aircraft.

# 7. DESCRIPTION OF AIRPLANE AND SYSTEMS

## TABLE OF CONTENTS

7.1 Aircraft	7-2
7.2 Airframe	7-2
7.3 Flight controls	7-2
7.4 Wing flap system	7-2
7.5 Trim system	7-2
7.6 Instrument panel	7-2
7.7 Safety harnesses	7-2
7.8 Landing gear	7-3
7.9 Engine	7-3
7.9.1 Engine specification	7-3
7.9.2 Engine operation speeds and limits	7-4
7.10 Propeller	7-5

TL2000/13/001AJ	Rev. No.: <b>3</b>	Original Issue Date: 6.6.2011 Revision Date: 3.3.2018	<b>7-1</b>
-----------------	--------------------	--	------------

	<b>Pilot's Operating Handbook</b>	Aircraft Type: TL - 2000 Sting S4
		Section 7 - Description of Airplane

Notice! The information contained in this document is for reference and information only.  
The pilot is the final and only responsible party for the safe operation of this aircraft.

## 7.1 Aircraft

The TL-2000 Sting S4 is a full three axis, one engine, low wing, two place, side-by-side seating, and tricycle landing gear aircraft with a steerable nose wheel.

## 7.2 Airframe

The primary aircraft structure is carbon fiber and fiberglass UV resistant reinforced laminate with a inner foam core creating a “sandwich” layered construction between each ply.

The canopy is designed to allow for a maximum outside view.

## 7.3 Flight controls

The aircraft's primary flight control system consists of two ailerons, a rudder, and a large elevator. The aileron and elevator control surfaces are mechanically, the rudder is manually operated by foot pedals.

## 7.4 Wing flap system

The aircraft utilizes standard split-type flaps that are controlled by a three-position electric controller positioned in the lower panel ahead of the crew seats. The control panel also contains a flap position indication. In first position are flaps totally retracted, in half position is angle of deflection 15° and flaps extended to full position has angle of deflection 40°.

## 7.5 Trim system

The rudder and right aileron are equipped with fixed, ground-adjustable trim tabs. The elevator has an in-flight, adjustable trim tab that is connected to a control lever in the cockpit.

## 7.6 Instrument panel

The instrument panel for the Sting S4 is arranged to suit the pilot's needs.

Sting flight instruments are arranged in the basic “T” configuration on the pilot (left) side of the aircraft. Exceptions can include the absence of a particular instrument or a variation in the order of the instruments at customer request.

## 7.7 Safety harnesses

Each seat in the aircraft is equipped with a four-point safety harness.

TL2000/13/001AJ	Rev. No.: <b>3</b>	Original Issue Date: 6.6.2011 Revision Date: 3.3.2018	<b>7-2</b>
-----------------	--------------------	--	------------

	<b>Pilot's Operating Handbook</b>	Aircraft Type: TL - 2000 Sting S4
		Section 7 - Description of Airplane

Notice! The information contained in this document is for reference and information only.  
The pilot is the final and only responsible party for the safe operation of this aircraft.

## 7.8 Landing gear

The landing gear is convention a fixed, tricycle type with a steerable nose gear and two main landing gears. Hydraulically-actuated brakes are attached on each main landing gear wheel.

## 7.9 Engine

### 7.9.1 Engine specification

Number of engines: **1**  
 Engine manufacturer: **ROTAX® G.m.b.H. Aircraft Engines**  
 Engine model Number: **912 iS**  
 Engine type: 4-cylinder, 4-stroke liquid/air cooled, engine with opposed cylinders, dry sump forced lubrication with separated oil tank, automatic adjustment by hydraulic valve tappet, redundant electric fuel injection, mechanical fuel pump, electronic dual ignition, electric starter, propeller speed reduction unit, air intake system

### NOTE

**For actual and complete information see the Operation manual for ROTAX engine supplied with the aircraft.**

### WARNING

**The ROTAX® 912iS engines are not certified. Even though the quality of assembly is of the highest priority to ROTAX®, failure of the engine may occur at any time. The pilot assumes full responsibility when operating the engine. The pilot is also responsible to fly the airplane at all times with the ability to glide and land safely in a predetermined area in case of engine failure.**

TL2000/13/001AJ	Rev. No.: <b>3</b>	Original Issue Date: 6.6.2011 Revision Date: 3.3.2018	<b>7-3</b>
-----------------	--------------------	--	------------

	<b>Pilot's Operating Handbook</b>	Aircraft Type: TL - 2000 Sting S4
		Section 7 - Description of Airplane

Notice! The information contained in this document is for reference and information only.  
The pilot is the final and only responsible party for the safe operation of this aircraft.

### 7.9.2 Engine operation speeds and limits

Engine type	ROTAX 912 iS
<b>Speed:</b>	
Take-off speed	5800 RPM (5 min.)
Max. continuous speed	5500 RPM
Idle speed	ca. 1400 RPM
<b>Performance (ISA): (International Standard Atmosphere)</b>	
Take-off performance	73,5 kW (100 BHP) at 5800 RPM
Max. continuous performance	69 kW (93BHP) at 5500 RPM
<b>Acceleration:</b>	
Limit of engine operating at zero gravity and in <b>negative „g“</b> conditions, max.	5 seconds at max. -0,5 g
<b>Reduction ratio:</b>	
Crankshaft : propeller shaft	2,27 : 1 2,43 : 1 (optional)
<b>Oil pressure:</b>	
Maximum	7 bar
Minimum	0,8 bar (12 psi) (below 3500 RPM)
Normal	3,0 ÷ 5,0 bar (44 ÷ 73 psi) (above 3500 RPM)
<b>Oil temperature:</b>	
Maximum	140°C (285°F)
Minimum	50°C (120°F)
Normal operating temperature	ca. 90 ÷ 110°C (190 ÷ 230°F)
<b>Cylinder head temperature:</b>	
Maximum – reading at observation point of the hotter cylinder head, ether no. 2 or no. 3	150°C (300°F)
<b>Engine start, operating temperature:</b>	
Maximum	50°C (120°F)
Minimum	- 25°C (- 13°F)
<b>Fuel pressure:</b>	
Maximum	3,2 bar (45 psi)
Minimum	2,8 bar (42 psi)

TL2000/13/001AJ	Rev. No.: <b>3</b>	Original Issue Date: 6.6.2011 Revision Date: 3.3.2018	<b>7-4</b>
-----------------	--------------------	--	------------

	<b>Pilot's Operating Handbook</b>	Aircraft Type: TL - 2000 Sting S4
		Section 7 - Description of Airplane

Notice! The information contained in this document is for reference and information only.  
The pilot is the final and only responsible party for the safe operation of this aircraft.

## 7.10 Propeller

Propeller installed on the airplane.

**Propeller manufacturer:** TL-ULTRALIGHT  
**Propeller model:** PowerMax  
**Number of blades:** 3  
**Propeller type:** In-flight adjustable  
**Propeller diameter:** 1748 mm

### NOTE

For actual and complete information see the manual from the relevant manufacturer.

TL2000/13/001AJ	Rev. No.: <b>3</b>	Original Issue Date: 6.6.2011 Revision Date: 3.3.2018	<b>7-5</b>
-----------------	--------------------	--	------------

	<b>Pilot's Operating Handbook</b>	Aircraft Type: TL - 2000 Sting S4
		Section 8 - Handling and Servicing

Notice! The information contained in this document is for reference and information only.  
The pilot is the final and only responsible party for the safe operation of this aircraft.

# 8. HANDLING AND SERVICING

## TABLE OF CONTENTS

8.1 Ground handling	8-2
8.1.1 Towing	8-2
8.1.2 Parking	8-2
8.1.3 Tie-down	8-2
8.2 Servicing	8-2
8.2.1 Engine oil	8-2
8.2.2 Fuel	8-3
8.2.2.1 Safety instruction and procedure of fuel tank filling	8-4
8.2.2.2. Procedure of fuel tank filling	8-5
8.3 Cleaning and care	8-5
8.3.1 Canopy	8-5
8.3.2 Propeller care	8-6
8.3.3 Engine care	8-7
8.3.4 Interior care	8-7

TL2000/13/001AJ	Rev. No.: <b>3</b>	Original Issue Date: 6.6.2011 Revision Date: 3.3.2018	<b>8-1</b>
-----------------	--------------------	--	------------



	<b>Pilot's Operating Handbook</b>	Aircraft Type: TL - 2000 Sting S4
		Section 8 - Handling and Servicing

Notice! The information contained in this document is for reference and information only.  
The pilot is the final and only responsible party for the safe operation of this aircraft.

## 8.1 Ground handling

### CAUTION

**Boarding the plane individually one by one.  
Otherwise, you can roll over or damage the aircraft.**

#### 8.1.1 Towing

The best way for maneuvering the aircraft on the ground is by use of the included tow bar connected to the nose gear on the aircraft. The tow bar should be used to guide the aircraft and actual force of pushing or pulling should be done by the pilot holding onto a propeller blade.

#### 8.1.2 Parking

The aircraft will roll with very little effort. When parking the aircraft, it is recommended to chock the tires in order to ensure that the aircraft will not move. The aircraft can be equipped with a parking brake. Tie down rings are installed underneath each wing if a greater need for security is considered necessary by the pilot.

#### 8.1.3 Tie-down

In the event that gusty or strong wind conditions exist, tying down the airplane is the best precaution to prevent damage. Metal screw rings are located underneath each wing tip for fastening tie-down straps or ropes. To tie-down the rear part of the airplane, use metal ring located under the rear part of the fuselage.

## 8.2 Servicing

#### 8.2.1 Engine oil

### NOTE

**For approved oil see the Operator's Manual for all version of ROTAX 912. Do not use oil additives. Quality automotive motor oil, not approved for aircraft motor oil – for viscosity see Operator's Manual for all version of ROTAX 912.**

Oil capacity: **3,5 l**  
Oil consumption: **max 0,06 l/h**

TL2000/13/001AJ	Rev. No.: <b>3</b>	Original Issue Date: 6.6.2011 Revision Date: 3.3.2018	<b>8-2</b>
-----------------	--------------------	--	------------

	<b>Pilot's Operating Handbook</b>	Aircraft Type: TL - 2000 Sting S4
		Section 8 - Handling and Servicing

Notice! The information contained in this document is for reference and information only.  
The pilot is the final and only responsible party for the safe operation of this aircraft.

Prior to checking the engine oil level, run the engine at idle for a few minutes. Then, shut it down. As an alternate method, turn the engine by pulling the propeller over, by hand.

## WARNING

**Before hand-cranking the propeller, ensure that both ignition switches are in the off position. For safety purposes, always treat a propeller as though the engine could start at any time while cranking.**

## WARNING

**Never turn the engine backwards (clockwise when viewed from the front to the rear of the aircraft) permanent damage to the engine may result due to loss of oil pressure to critical components.**

Open the access panel on the upper cowling. To check the oil, unscrew the cap of the oil reservoir located at the rear of the firewall. Remove the dipstick to check the oil level. A flattened segment at the end of the dipstick represents the oil capacity range. The top of this segment is the MAX limit and the bottom of the segment is the MIN limit. Ensure the oil level is between these limits, but it must **never** fall below the MIN limit.

To best protect your engine, change the engine oil and replace the oil filter every 25 hours of engine operating time or after cross-country operation with 100LL Avgas.

### 8.2.2 Fuel

## NOTE

**For approved fuel see the Operator's Manual for all version of ROTAX 912.**

## NOTE

**It is recommended to avoid fuels that contain ethanol.**

TL2000/13/001AJ	Rev. No.: <b>3</b>	Original Issue Date: 6.6.2011 Revision Date: 3.3.2018	<b>8-3</b>
-----------------	--------------------	--	------------

Notice! The information contained in this document is for reference and information only.  
The pilot is the final and only responsible party for the safe operation of this aircraft.

**CAUTION**

**100LL Avgas is to be used only as an alternate fuel type if 91 octane auto fuel is not available. The use of 100LL Avgas is restricted to less than 30% of engine operation time.**

**CAUTION**

**Before each flight remember to control and purge the fuel system and check the filter in the gascolator.**

Fuel specification: **Premium automotive unleaded that conform to ASTM D 4814**  
**Minimum AKI 89 ROTAX® 912 UL**  
**Minimum AKI 91 ROTAX® 912 ULS**

Total fuselage capacity:	<b>77 l</b>
Wing fuel tanks capacity:	<b>2 x 22 l (if installed)</b>
Total fuel capacity (if wing tanks installed):	<b>121 l</b>
Total unusable:	<b>5,6 l</b>
Fuel consumption:	<b>max. 27 l/h</b>
Approved fuel grade:	<b>91 unleaded auto gas (yellow)</b>
Alternate fuel grade:	<b>100LL Avgas (blue) (for less than 30% of engine operation time):</b>

**8.2.2.1 Safety instruction and procedure of fuel tank filling**

**Safety instruction for filling fuel into the airplane tank(s)**

- The fuel tank can be filled with fuel only by those individuals who are fully instructed and familiar with all fuel safety instructions.
- It is prohibited to fill the fuel tank during rain, storm, in closed space, when engine is operating or with electric system switched on.
- The person filling the fuel tank must not be wearing polyester clothing or any clothing from a material which creates static electricity.
- Do not smoke, use a cell phone, any static producing device, handle open flame or any electrical device during refueling.

	<b>Pilot's Operating Handbook</b>	Aircraft Type: TL - 2000 Sting S4
		Section 8 - Handling and Servicing

Notice! The information contained in this document is for reference and information only.  
The pilot is the final and only responsible party for the safe operation of this aircraft.

### 8.2.2.2. Procedure of fuel tank filling

- Ground the airplane. The airplane ground point is located on the engine exhaust pipe.
- Open the fuel tank cap.
- Fill with necessary quantity of fuel.

## CAUTION

**When filling into the airplane, avoid fuel contact with the airplane finish which may cause damage to surface of the airplane.**

- When the airplane is filled with fuel, wipe the filler neck fuel and close the fuel neck filler cap.
- Remove conductive interconnection between the filling device and the airplane.

## WARNING

**When fueling the airplane, ensure the airplane is electrically grounded by verifying that the grounding wire located on the right main gear wheel makes adequate contact with the ground's surface. Also, ensure the fueling container remains adequately grounded to fuel neck ring and nozzle. A ground wire from the refueling container should be attached to the engine exhaust pipe. The exhaust pipe is electrically connected to the aircraft ground system as are all fuel tanks and tank opening ports.**

## 8.3 Cleaning and care

### 8.3.1 Canopy

The canopy surface should be cleaned only with an aircraft windshield cleaner and one of the micro-fiber cloths which are provided. Do not wipe the canopy in a circular motion. If the canopy is covered with dust, use flowing clean water and lightly wipe the dust away with a clean hand (remove finger rings). This will remove (flow away) the grit that will scratch the plastic surface. Apply a sufficient but modest amount of cleaner to the canopy surface and wipe in a long stroke fore/aft **linear** motion with light pressure until the surface is clear. Attempt to lift the dirt from the surface don't rub it into the canopy or light scratches will appear in the sunlight reflections.

TL2000/13/001AJ	Rev. No.: <b>3</b>	Original Issue Date: 6.6.2011 Revision Date: 3.3.2018	<b>8-5</b>
-----------------	--------------------	--	------------

	<b>Pilot's Operating Handbook</b>	Aircraft Type: TL - 2000 Sting S4
		Section 8 - Handling and Servicing

Notice! The information contained in this document is for reference and information only.  
The pilot is the final and only responsible party for the safe operation of this aircraft.

**CAUTION**

**Never use glass cleaner, MEK, acetone, benzene, gasoline, fire extinguisher, anti-ice fluid, or lacquer thinner to clean plastic. These materials will attack the plastic and cause it to craze.**

**NOTE**

**See chapter 4.2.16 Canopy manipulation for more information about manipulation with canopy.**

**CAUTION**

**Do not use a canvas cover on the canopy unless freezing rain or sleet is anticipated because the cover may scratch the plastic surface. Use only the proper canopy cover provided with the aircraft.**

**CAUTION**

**It is always necessary to close the canopy when the aircraft stands out of hangar in the direct sun. By open canopy there is a danger of burn-out of instrument panel cover.**

**8.3.2 Propeller care**

Proper preflight inspections of the propeller blades for nicks and cracks are key to maintaining a good propeller. Wiping down the blades to clean off bugs and grass is also advisable after EVERY flight. Whenever the airplane is parked, place the propeller covers over the blades to ensure that they are protected from the environment. A clean waxed propeller resists stains and is more efficient.

TL2000/13/001AJ	Rev. No.: <b>3</b>	Original Issue Date: 6.6.2011 Revision Date: 3.3.2018	<b>8-6</b>
-----------------	--------------------	--	------------

	<b>Pilot's Operating Handbook</b>	Aircraft Type: TL - 2000 Sting S4
		Section 8 - Handling and Servicing

Notice! The information contained in this document is for reference and information only.  
The pilot is the final and only responsible party for the safe operation of this aircraft.

### 8.3.3 Engine care

Routinely perform a visual inspection of the engine. Check all oil, fuel, and coolant lines for any leakages, defective seals, or faulty connections. Ensure all electrical leads are fastened down tightly to help prevent intermittent electric problems. Check coolant, brake fluid, and engine oil levels to determine if there are any losses.

Clean the radiator vanes from bugs and debris using a low pressure water hose and a cloth. Never use high pressure water to clean out the radiator. If a fault or discrepancy is discovered or any question is raised about the condition of the engine, consult a properly trained professional before operating the engine

### 8.3.4 Interior care

To remove dust, loose dirt, and other debris from the upholstery and carpet, clean the interior regularly with a vacuum cleaner. Blot up any spilled liquids promptly and use stain remover as needed. Sticky substances can be removed by using a knife or scraper and then stain remover. Clean the instrument panel and control knobs with a very mild, non-conductive cleaner in order to remove oily deposits without compromising any electronic components.

TL2000/13/001AJ	Rev. No.: <b>3</b>	Original Issue Date: 6.6.2011 Revision Date: 3.3.2018	<b>8-7</b>
-----------------	--------------------	--	------------

Notice! The information contained in this document is for reference and information only.  
The pilot is the final and only responsible party for the safe operation of this aircraft.

# 9. SUPPLEMENTS

## TABLE OF CONTENTS

9.1	Required placards & markings	<b>9-2</b>
9.2	Placards	<b>9-2</b>
9.3	Exterior markings	<b>9-5</b>

Notice! The information contained in this document is for reference and information only.  
The pilot is the final and only responsible party for the safe operation of this aircraft.

## 9.1 Required placards & markings

This section contains a list of both placards and markings located inside the cockpit and on the exterior of the airplane. These placards and markings provide guidance, instruction, or caution. **It is the responsibility of the owner/pilot to understand and comply with the directions of both the placards and markings.**

## 9.2 Placards

Attached to the safety pin on the rocket safety parachute system activation handle:



Center panel in view of pilot seating:

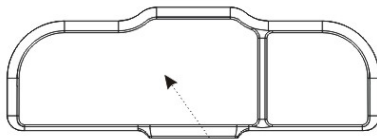

This aircraft was manufactured in accordance with Light Sport Aircraft airworthiness standards and does not conform to standard category airworthiness requirements

At instrument panel in pilot view:

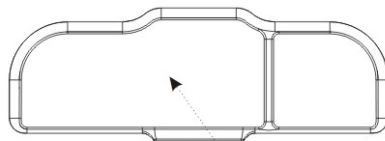

ALL AEROBATIC MANEUVERS  
INCLUDING INTENTIONAL SPINS  
**PROHIBITED**



Notice! The information contained in this document is for reference and information only.  
The pilot is the final and only responsible party for the safe operation of this aircraft.

At instrument panel in pilot view:

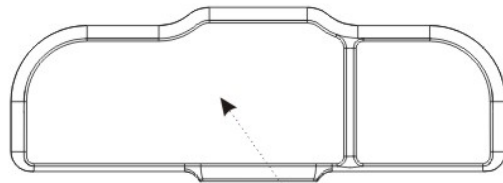

**FLAP SPEED LIMITS**  
75 KTS - 15°  
65 KTS - 40°

At instrument panel in pilot view:

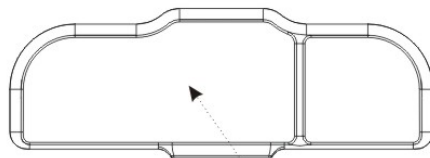

Flight operations in IMC are  
**PROHIBITED**

Alerts for crew to the presence of ballistic rescue system on the plane

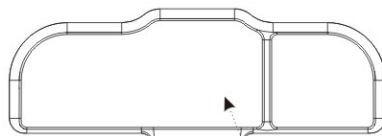

	<b>Pilot's Operating Handbook</b>	Aircraft Type: TL - 2000 Sting S4
		Section 9 - Supplements

Notice! The information contained in this document is for reference and information only.  
The pilot is the final and only responsible party for the safe operation of this aircraft.

Maximum weight of the baggage:

**MAX. 25 KG**

Marking of external socket 12V (according to aircraft equipment):

**12 V**

Aircraft category - instrument panel in pilot view:

**LIGHT SPORT**

TL2000/13/001AJ	Rev. No.: <b>3</b>	Original Issue Date: 6.6.2011 Revision Date: 3.3.2018	<b>9-4</b>
-----------------	--------------------	--	------------

Notice! The information contained in this document is for reference and information only.  
The pilot is the final and only responsible party for the safe operation of this aircraft.

### 9.3 Exterior markings

Around main wing fuel tank caps: Circular marker:



Around wing tank caps: (if installed)



Around drain valves on the bottom side of the wings: (if wing tanks installed)



	<b>Pilot's Operating Handbook</b>	Aircraft Type: TL - 2000 Sting S4
		Section 9 - Supplements

Notice! The information contained in this document is for reference and information only.  
The pilot is the final and only responsible party for the safe operation of this aircraft.

Around venting of fuel tanks on the bottom side of the wings: (if wing tanks installed)



Around point of taking the static pressure at the rear part of the fuselage:



Marking of control surfaces (aileron, flaps, elevator, rudder – flettner )

**NO PUSH**

Marking of the trim:

**NO LIFT**

TL2000/13/001AJ	Rev. No.: <b>3</b>	Original Issue Date: 6.6.2011 Revision Date: 3.3.2018	<b>9-6</b>
-----------------	--------------------	--	------------

Notice! The information contained in this document is for reference and information only.  
The pilot is the final and only responsible party for the safe operation of this aircraft.

Front wheel max. tire pressure:

**2,5 bar 36 PSI**

Main wheel max. tire pressure:

**2,5 bar 36 PSI**

Parachute rocket exit panel:



Rocket Deployed Parachute Egress Area  
**STAY CLEAR**  
GalaxyUSA  
Emergency information at [www.galaxysky.cz](http://www.galaxysky.cz)  
Or call 1.501.228.7777



Rocket Deployed Parachute Egress Area  
**STAY CLEAR**  
GRS - GALAXY RESCUE PARACHUTE SYSTEMS  
GALAXY HIGH TECHNOLOGY s.r.o.  
Contact your local agent: [www.galaxysky.cz](http://www.galaxysky.cz)

TL2000/13/001AJ	Rev. No.: <b>3</b>	Original Issue Date: 6.6.2011 Revision Date: 3.3.2018	<b>9-7</b>
-----------------	--------------------	--	------------